

# GLORIOUS

www.glorious.de

## SOUND DESK COMPACT

**Aufbauanleitung**  
**Assembly Instructions**  
**Notice de montage**

**For Versions:**

- Black
- White
- Walnut



**Wir gratulieren Ihnen zum Kauf des Glorious Sound Desk Compact. Folgen Sie den Schritten der Aufbauanleitung.**

Nehmen Sie die Bauteile des Glorious Sound Desk Compact aus der Verpackung. Bitte überprüfen Sie, ob kein offensichtlicher Transportschaden vorliegt. Sollten Sie Schäden entdecken, setzen Sie sich bitte mit Ihrem Fachhändler in Verbindung.

**Congratulations on purchasing the Glorious Sound Desk Compact. Follow the instruction manual's steps.**

Remove all component parts from their packaging. Please make sure that the components did not suffer any visible damage during transport. If you detect any damage please do not operate this equipment and contact your specialized dealer.

**Nous vous félicitons d'avoir acheté le Glorious Sound Desk Compact. Suivez les étapes du guide de montage.**

Retirez les éléments de la Glorious Sound Desk Compact de l'emballage et vérifiez qu'ils soient tous exempts d'un quelconque dommage de transport. Si vous détectez le moindre d'faut, veuillez contacter votre revendeur.

## Bestimmungsgemäße Verwendung

Bei diesem Produkt handelt es sich um einen Arbeitstisch für Musiker und Produzenten, der Platz für Equipment und Zubehör bietet.

## Application in accordance with regulations

This product is a workstation for musicians and producers and offers space for equipment and accessories.









## Usage conforme

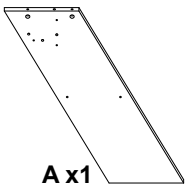
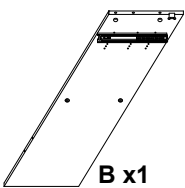
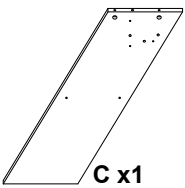
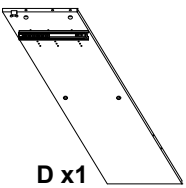
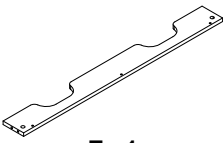
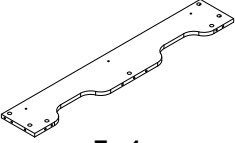
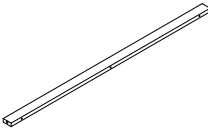
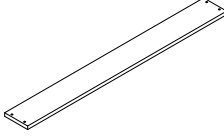
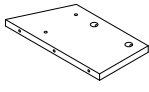
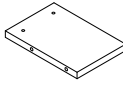
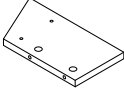
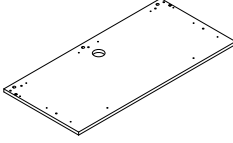
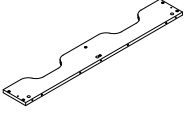
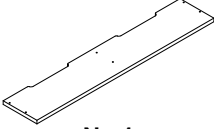
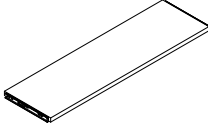
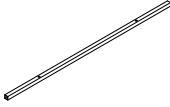

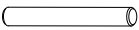
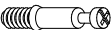
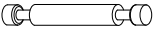

Le produit est une table de travail pour musiciens ou producteurs et offre espace pour équipement et accessoires.

## Bauteile

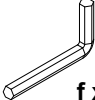
## Components

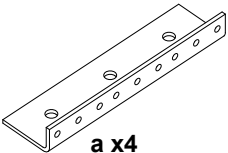
## Éléments constitutifs

 <b>A x1</b>	 <b>B x1</b>	 <b>C x1</b>	 <b>D x1</b>
 <b>E x1</b>	 <b>F x1</b>	 <b>G x1</b>	 <b>H x1</b>
 <b>I x1</b>	 <b>J x1</b>	 <b>K x1</b>	 <b>L x1</b>
 <b>M x1</b>	 <b>N x1</b>	 <b>O x1</b>	 <b>P x1</b>
 <b>Q x2</b>	 <b>R x14</b>	 <b>S x4</b>	 <b>T x23</b>
 <b>U x3</b>	 <b>V x29</b>	 <b>W x6</b>	 <b>X x18</b>
 <b>Y x33</b>	 <b>Z x1</b>	<b>TOOL</b>	 <b>f x1</b>

3U accessories			
 <b>a x4</b>	 <b>b x6</b>	 <b>c x6</b>	 <b>d x24</b>
			 <b>e x24</b>

# Montage

# Assembly

# Montage

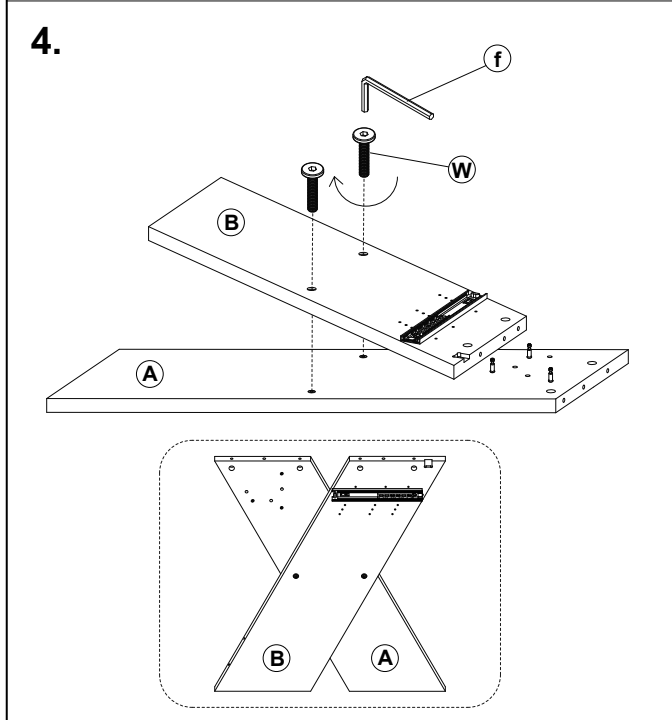
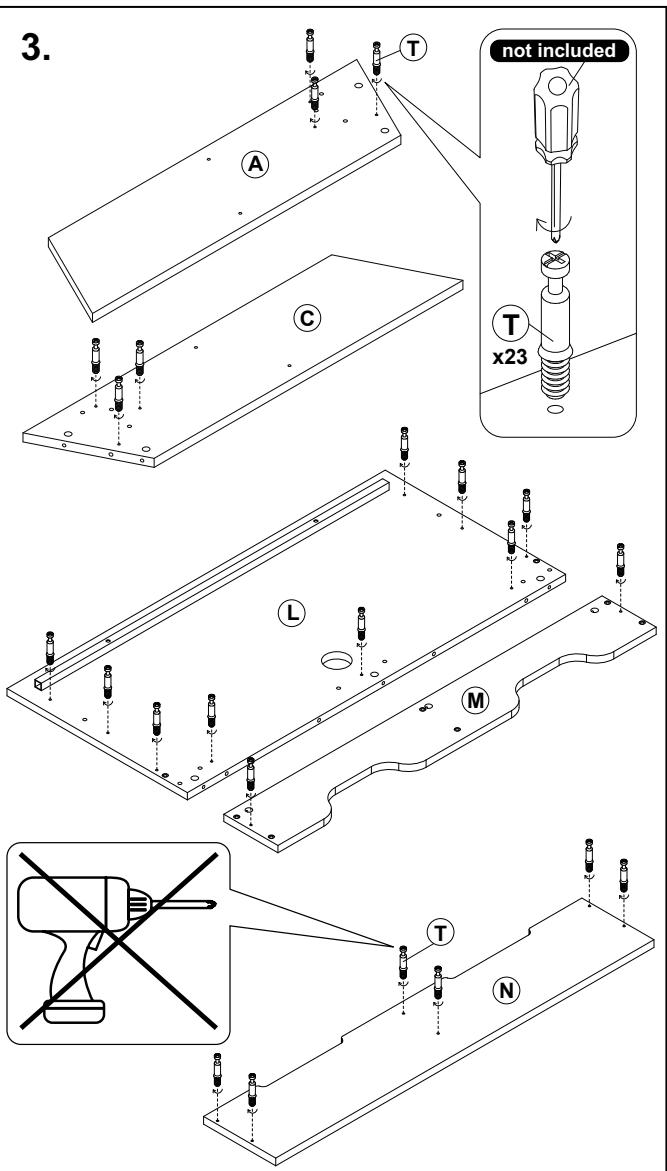
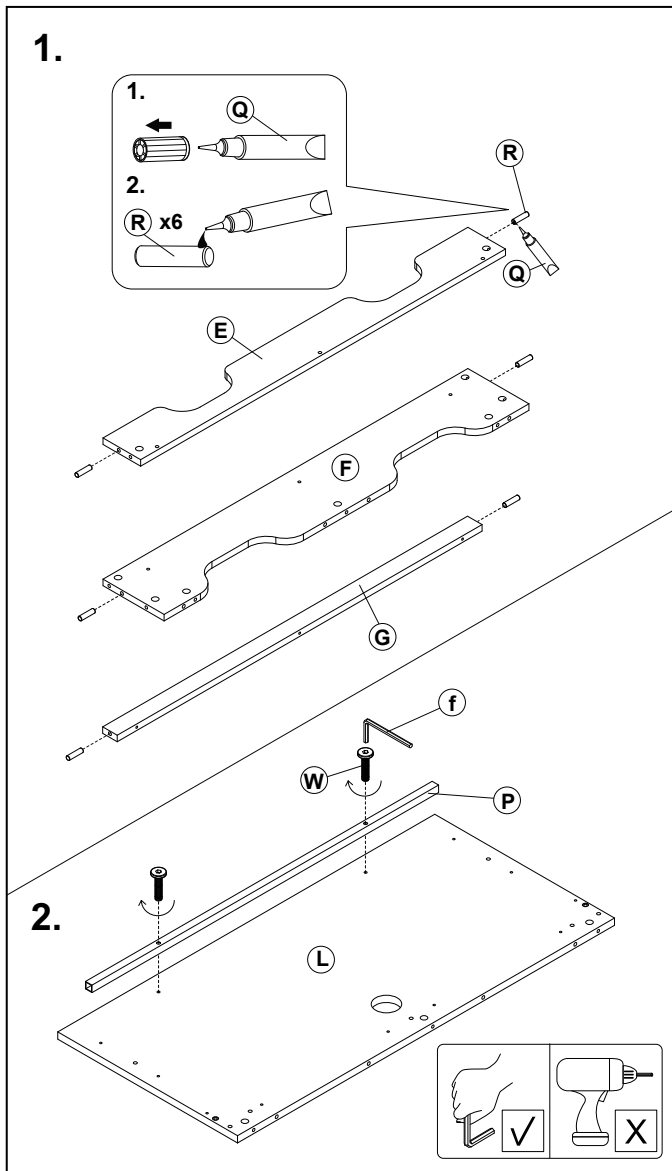

# Montage

# Assembly

# Montage

**6.**

**7.**

**8.**

**9.**

**10.**

**1.** Q

**2.** R x3

**1.** V

**2.** V

**1.** V

**2.** V

**1.** Y x4

**2.** W

**1.** Y x4

**2.** X

**1.** Y x4

**2.** V

# Montage

# Assembly

# Montage

**11.** **12.** **13.**

**14.** **15.**

**16.** **17.**

**18.** **19.**

# Notice of adjustable keyboard tray

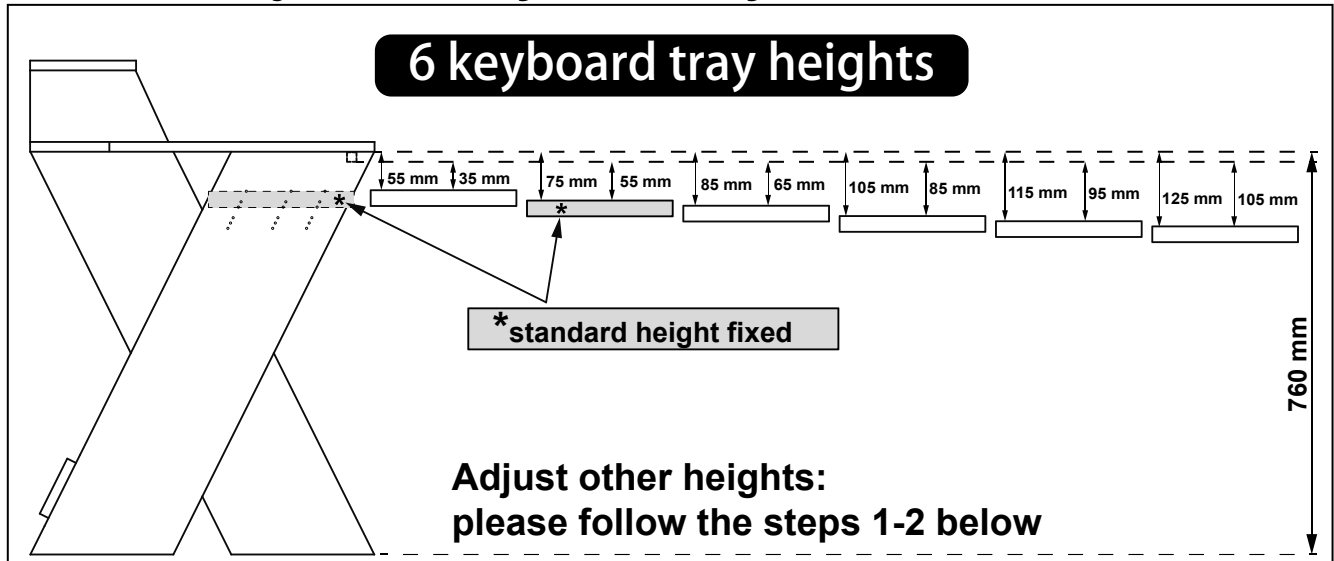

## step 1.

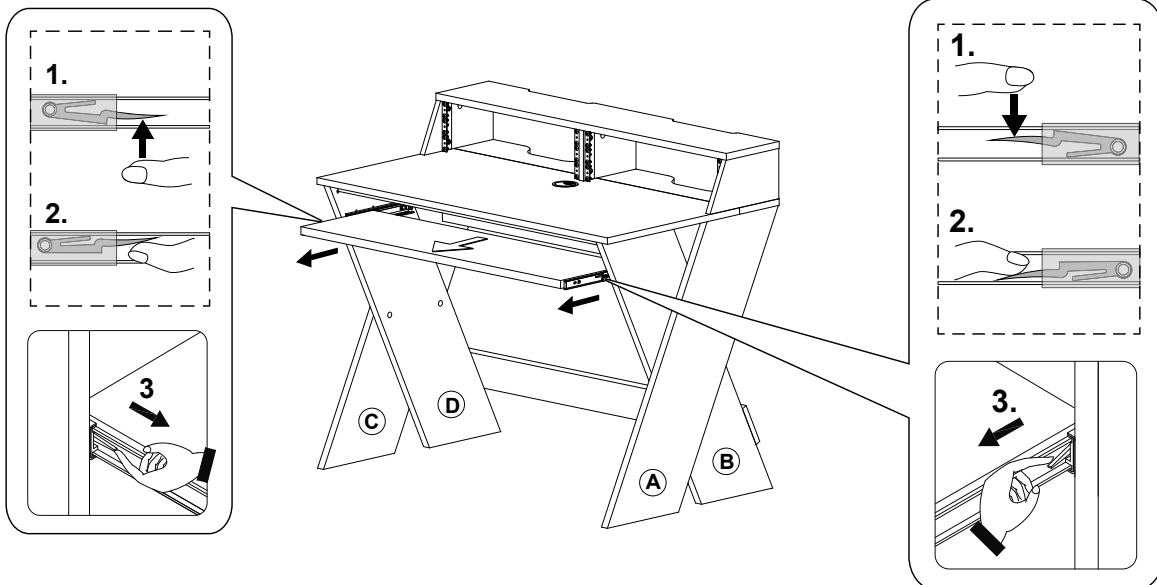

## step 2.

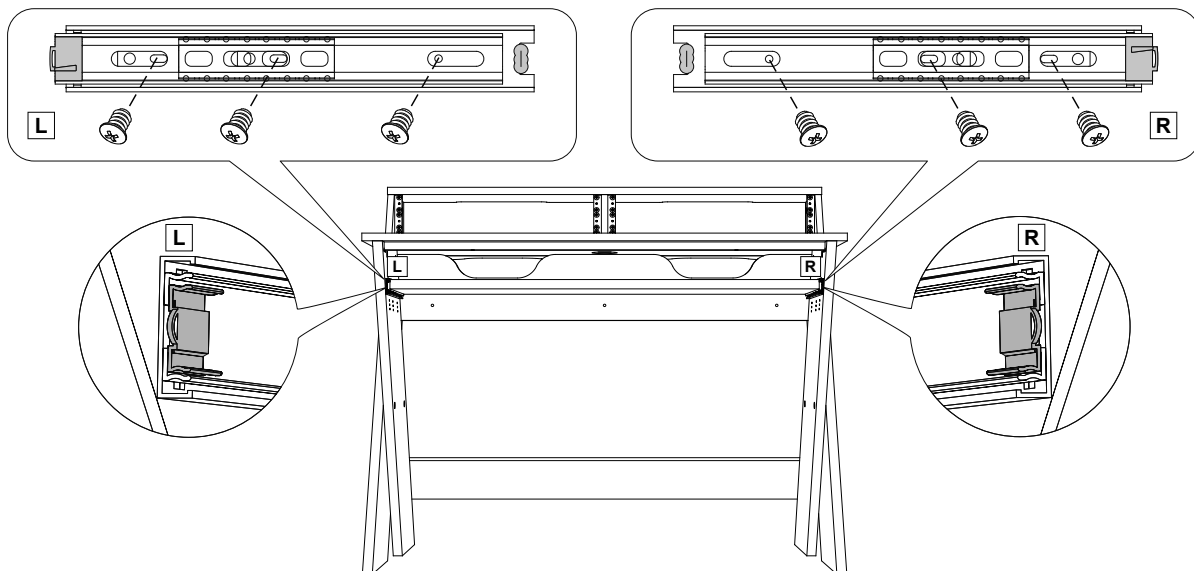

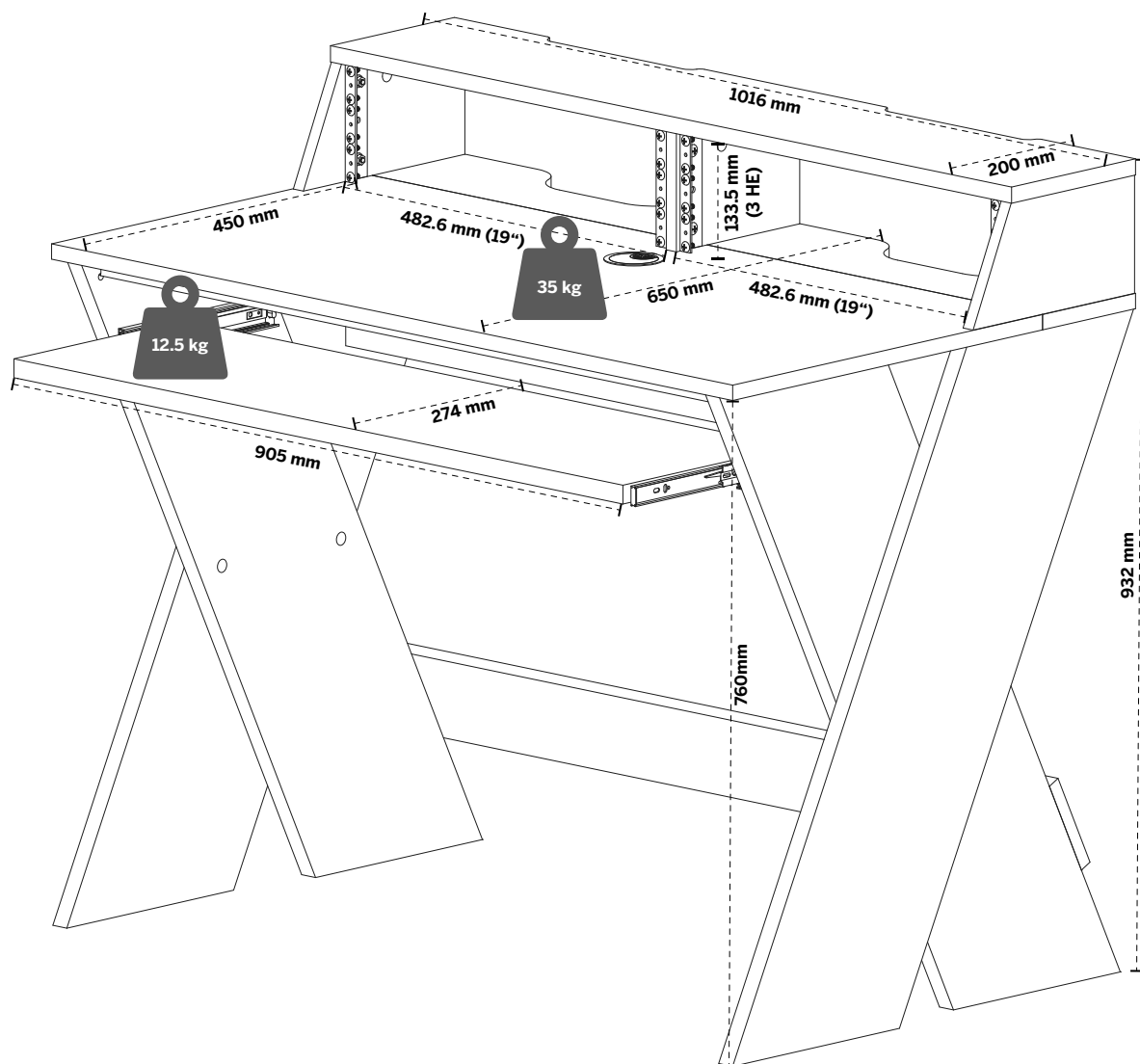

## Technische Daten

### Material:

- Holzfaserplatte, Hohlplatte, Wabenkarton, Vierkantröhr aus Eisen

### Maße:

- 1016 (b) x 650 (t) x 932 (h) mm

### Gewicht:

- 25,83 kg (Produkt)
- 27,42 kg (mit Verpackung)

### Belastbarkeit Keyboard-Ablage bis:

- 12,5 kg (empfohlen)
- 15 kg (maximal)

### Maximale Belastbarkeit Haupt-Ablage:

- 35 kg

Lieferung ohne Dekoration

## Technical Information

### Material:

- Particle Board, Hollow Board, Honeycomb Board, Squared Iron Tube

### Dimensions:

- 1016 (w) x 650 (d) x 932 (h) mm

### Weight:

- 25,83 kg (Product)
- 27,42 kg (with Packaging)

### Load keyboard tray up to:

- 12,5 kg (recommended)
- 15 kg (max)

### Maximum load desk top:

- 35 kg

Delivery without decoration

## Caractéristiques

### Matériau:

- Panneaux de fibres, panneau creux, Panneau en nid d'abeille, Tube en fer carré

### Dimensions:

- 1016 (l) x 650 (p) x 932 (h) mm

### Poids:

- 25,83 kg (Produit)
- 27,42 kg (avec emballage)

### Charge maximale du plateau du clavier:

- 12,5 kg (recommandé)
- 15 kg (maximum)

### Charge maximale:

- 35 kg

Livré sans décoration

# GLORIOUS

w w w . g l o r i o u s . d e

Glorious wünscht Ihnen nun viel Spaß!  
Have fun with your Glorious!  
Glorious vous souhaite beaucoup de plaisir!

## FINE FITTING FURNITURE

Modular Solution

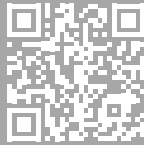

Vinyl Frames

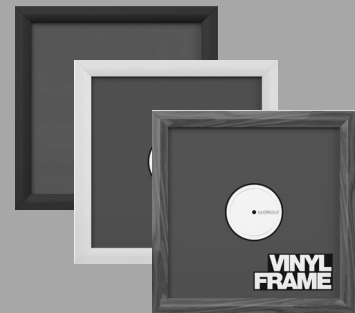

Turntable  
Lowboard

